

## RF-35HTC High Thermal Conductivity Laminate

RF-35HTC is a non-reinforced, low loss, industry leading thermally conductive laminate. The high 1.84 watts/M\*K thermal conductivity is well suited for any high-power application including amplifiers, couplers, dividers, filters etc. RF-35HTC is a ceramic/PTFE composite that is very low in PTFE content. The extremely low loss of 0.0007 at 10 GHz makes RF-35HTC very attractive for any high-power application.

The high thermal conductivity is beneficial for moving localized heat away from transistors, capacitors, conductors, other components, or the dielectric material. In hot environments exposed to oxygen, hydrocarbon (synthetic rubber) based composites are prone to oxidation and higher than expected electrical/thermal losses predicted from modeling. PTFE is attractive at the highest of temperatures because PTFE resists any thermal oxidation.

Uniform distribution of ceramic in the dielectric ensures a uniform dielectric in the X, Y, and Z directions. The low X and Y CTE ensures good performance of filters over temperature. The low Z axis expansion ensures stable performance of narrow band or broad band couplers over temperature and stable signal to ground plane dielectric thickness (stable impedance) over temperature. The low PTFE content of RF-35HTC facilitates plating and drilling in printed circuit board fabrication. The high concentration of ceramic contributes to improved dimensional stability. AGC has avoided the use of alumina that is abrasive to mechanical drilling or routing.

Power handling experiments were conducted on microstrip transmission lines with and without various capacitors at the center of the microstrip to quantify the capability of the dielectric to spread thermal energy. The heat profile of the microstrip, both with and without a capacitor, and any hot spots was captured using a thermal camera. Transmitted power was increased to 200 Watts. AGC's RF-35HTC was compared to AGC's RF-35TC and RF-35TC-A, as well as to two available competitive materials. In every case, the RF-35HTC dielectric material outperformed all other materials in its ability to spread thermal energy, as shown on page 2.

RF-35HTC is compatible with all AGC 1 oz copper with ULP 1 oz copper being recommended at high frequencies for the lowest insertion losses. Please consult with your technical sales manager about which coppers are most suitable for your application when using 1/2 oz copper.

### Benefits & Applications:

- Best in Class Thermal Conductivity
- Low Loss Tangent
- No Glass Reinforcement
- Resists Thermal Oxidation
- High Dimensional Stability

- High power applications such as filters, couplers, dividers & power amplifiers
- Antennas
- Satellites

# RF-35HTC High Thermal Conductivity Laminate

## Power Handling Test Configuration for Various Laminate Materials

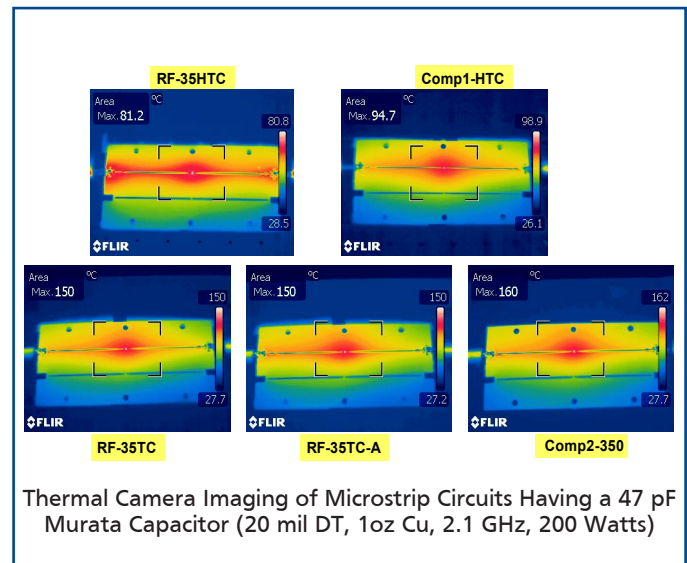
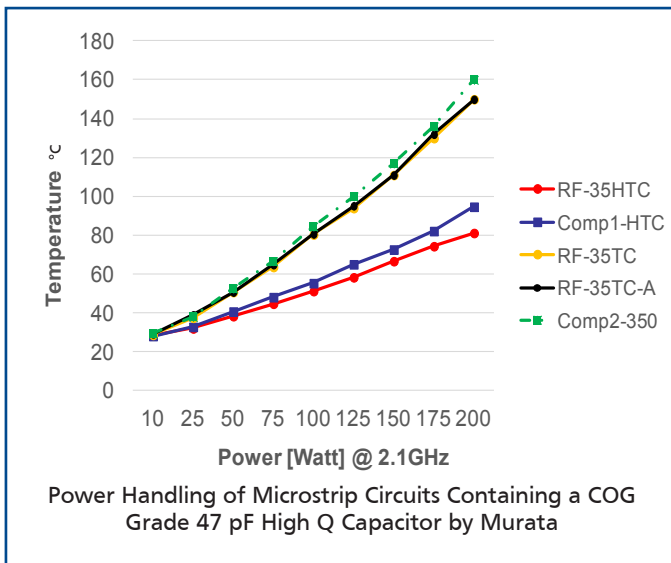
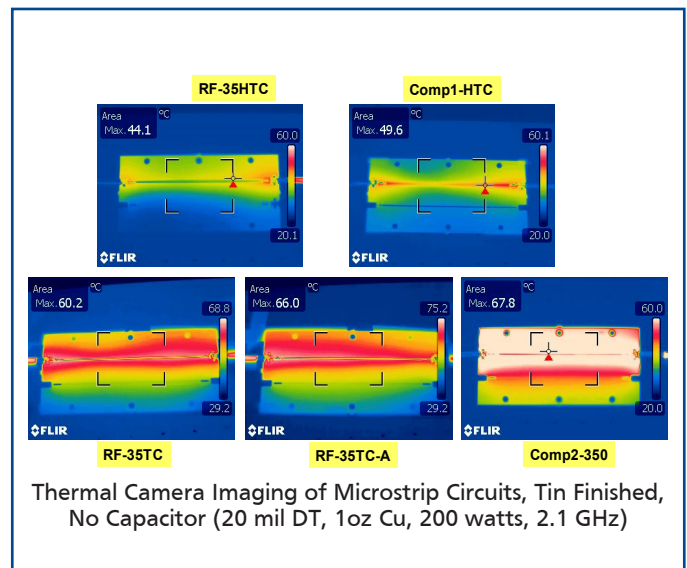
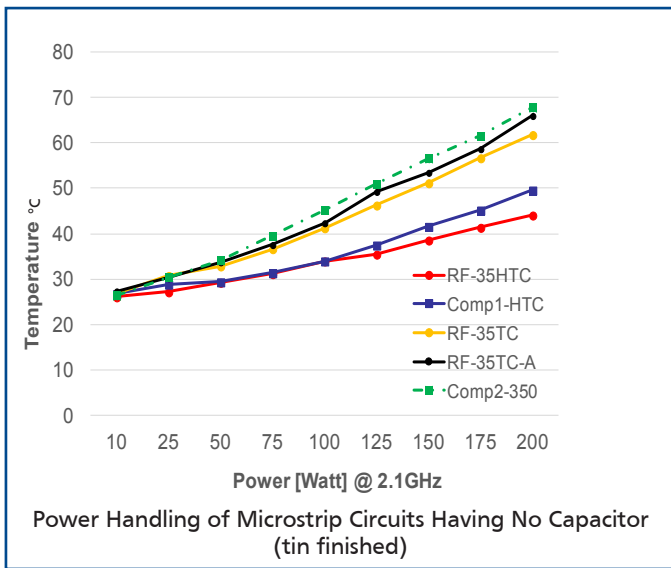
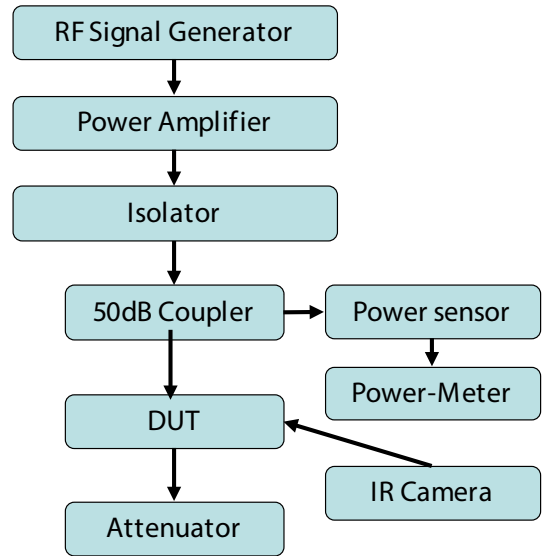
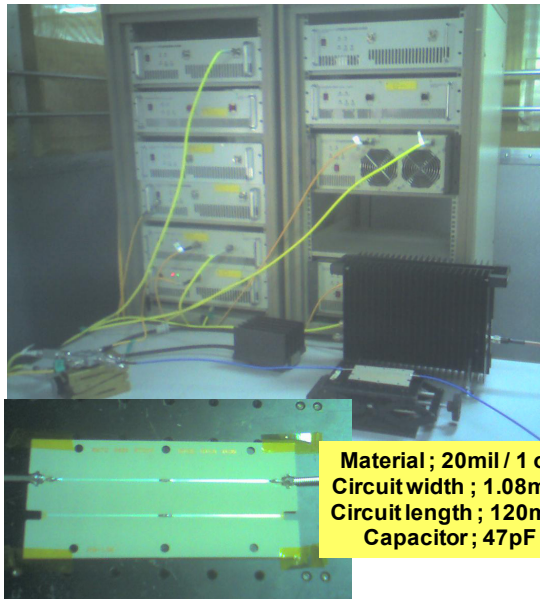

RF-35HTC Typical Values					
Property	Test Method	Unit	Value	Unit	Value
Dk @ 10 GHz (Bereskin)	IPC-650 2.5.36		3.50 +/- 0.05		3.50 +/- 0.05
Df @ 10 GHz (Bereskin)	IPC-650 2.5.36		0.0007		0.0007
T <sub>c</sub> K (-55 to 100 °C)	IPC-650 2.5.5.5.1	ppm	-19	ppm	-19
Dielectric Breakdown	IPC-650 2.5.6 (In-Plane, Two Pins in Oil)	kV	42	kV	42
Dielectric Strength	ASTM D 149 (Through Plane)	V/mil	212	kV/mm	8.4
Arc Resistance	IPC-650 2.5.1	Seconds	≥ 400	Seconds	≥ 400
Flexural Strength (MD)	ASTM D 790 / IPC-650 2.4.4	psi	2670	MPa	18.4
Flexural Strength (CD)	ASTM D 790 / IPC-650 2.4.4	psi	2560	MPa	17.7
Tensile Strength (MD)	ASTM D 3039 / IPC-TM-650 2.4.19	psi	957	MPa	6.6
Tensile Strength (CD)	ASTM D 3039 / IPC-TM-650 2.4.19	psi	899	MPa	6.2
Elongation at Break (MD)	ASTM D 3039 / IPC-TM-650 2.4.19	%	4.1	%	4.1
Elongation at Break (CD)	ASTM D 3039 / IPC-TM-650 2.4.19	%	9.9	%	9.9
Young's Modulus (MD)	ASTM D 3039 / IPC-TM-650 2.4.19	psi	414,228	MPa	2856
Young's Modulus (CD)	ASTM D 3039 / IPC-TM-650 2.4.19	psi	388,121	MPa	2676
Poisson's Ratio (MD)	ASTM D 3039 / IPC-TM-650 2.4.19		0.08		0.08
Poisson's Ratio (CD)	ASTM D 3039 / IPC-TM-650 2.4.19		0.08		0.08
Compressive Modulus	ATSM D 695 (23 °C)	psi	511,000	MPa	3523
Flexural Modulus (MD)	ASTM D 790 / IPC-650 2.4.19	psi	418,000	MPa	2882
Flexural Modulus (CD)	ASTM D 790 / IPC-650 2.4.19	psi	386,000	MPa	2661
Peel Strength (1 oz. CL1)	IPC-650 2.4.8 (Thermal Stress)	lbs/in	6.17	N/mm	1.08
Thermal Conductivity (unclad)	ASTM F433, ASTM E1461 (Laser Flash)	W/M*K	1.84	W/M*K	1.84
Thermal Conductivity (clad)	ASTM F433, ASTM E1461 (Laser Flash)	W/M*K	2.89	W/M*K	2.89
Moisture Absorption	IPC-650 2.6.2.1	%	0.07	%	0.07
Dimensional Stability (MD)	IPC-650-2.4.39 Sec. 5.4 (After Etch)	mils/in.	-0.01	mm/M	-0.01
Dimensional Stability (CD)	IPC-650-2.4.39 Sec. 5.4 (After Etch)	mils/in.	-0.01	mm/M	-0.01
Dimensional Stability (MD)	IPC-650-2.4.39 Sec. 5.5 (Thermal Stress)	mils/in.	-0.05	mm/M	-0.05
Dimensional Stability (CD)	IPC-650-2.4.39 Sec. 5.5 (Thermal Stress)	mils/in.	-0.02	mm/M	-0.02
Surface Resistivity	IPC-650 2.5.17.1 (After elevated temp.)	Mohms	7.2 x 10 <sup>6</sup>	Mohms	7.2 x 10 <sup>6</sup>
Surface Resistivity	IPC-650 2.5.17.1 (After humidity)	Mohms	1.3 x 10 <sup>5</sup>	Mohms	1.3 x 10 <sup>5</sup>
Volume Resistivity	IPC-650 2.5.17.1 (After elevated temp.)	Mohms/cm	1.7 x 10 <sup>9</sup>	Mohms/cm	1.7 x 10 <sup>9</sup>
Volume Resistivity	IPC-650 2.5.17.1 (After humidity)	Mohms/cm	2.9 x 10 <sup>6</sup>	Mohms/cm	2.9 x 10 <sup>6</sup>
CTE (X axis) (23 to 125 °C)	IPC-650 2.4.41 / ASTM D 3386	ppm/°C	11	ppm/°C	11
CTE (Y axis) (23 to 125 °C)	IPC-650 2.4.41 / ASTM D 3386	ppm/°C	14	ppm/°C	14
CTE (Z axis) (23 to 125 °C)	IPC-650 2.4.41 / ASTM D 3386	ppm/°C	77	ppm/°C	77
Density	ASTM D 792	g/cm <sup>3</sup>	2.28	g/cm <sup>3</sup>	2.28
Hardness	ASTM D 2240 (Shore D)		60.2		60.2
Specific Heat	ASTM E 1269-5, E 967-08, E 968-02	j/(g °C)	0.982	j/(g °C)	0.982
T <sub>d</sub> (2% Wt. Loss)	IPC-650 2.4.24.6/TGA	° F	975	° C	524
T <sub>d</sub> (5% Wt. Loss)	IPC-650 2.4.24.6/TGA	° F	1011	° C	544

All reported values are typical and should not be used for specification purposes. In all instances, the user shall determine suitability in any given application.

# RF-35HTC High Thermal Conductivity Laminate

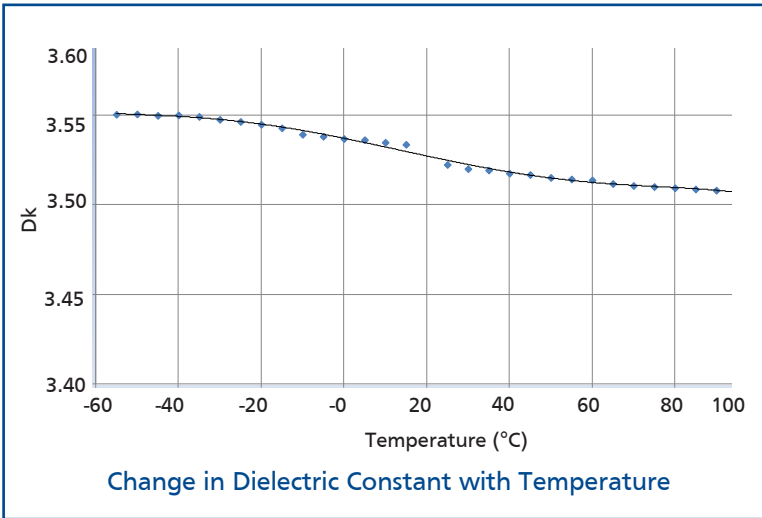

Designation	Dielectric Constant
RF-35HTC	3.50 +/- 0.05

Available Sheet Sizes	
Inches	mm
12 x 18	304 x 457
16 x 18	406 x 457
18 x 24	457 x 610
16 x 36	406 x 914
24 x 36	610 x 914
18 x 48	457 x 1220

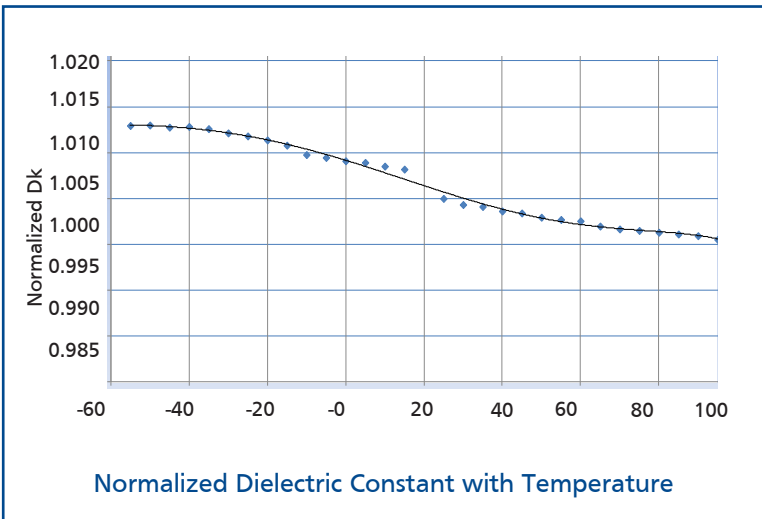

Thickness Tolerance		Thickness Availability	
mil	mm	mil	mm
Class C	Class C	Incr. of 5	Incr. of 0.127

Typical Thickness	
Inches	mm
.0050, 0.0100, 0.0200	0.13, 0.25, 0.51
.0300, 0.0600, 0.0900	.76, 1.52, 2.29

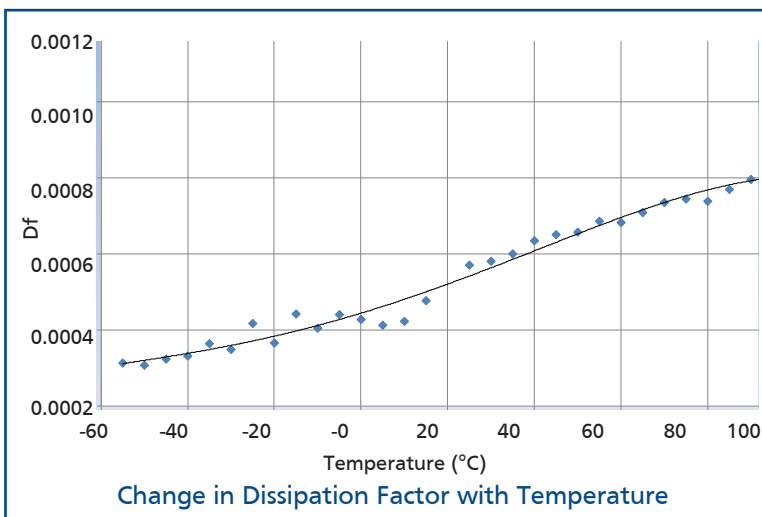

Please see our Product Selector Guide for Information on available copper cladding.

An Example of our part number is:  
**RF-35HTC-0300-C1/C1-18" x 24"**  
**(457 mm x 610 mm)**

